

PRODUCT DESCRIPTION

MONOLITHIC, PROGRAMMABLE, FULL-BRIDGE MOTOR DRIVER INTEGRATES PWM CURRENT CONTROL AND ‘MIXED-MODE’ MICROSTEPPING

Paul Emerald, Roger Peppiette, and Anatol Seliverstov

INTRODUCTION to ‘MIXED-MODE, IC

Specifically created and intended for bidirectional current control of two-phase step motors, this IC merges pulse-width-modulation (PWM) current regulation with innovative mode control circuitry. Although singularly targeted for bipolar-drive of ‘series connected’ step motors, the digital current control techniques incorporated in the device may prove useful in other inductive load applications.

The user selectable choices include: programming (regulating) the load current; setting the duration of the fixed OFF-time interval; mode control of the (decaying) recirculation current; and ‘tuning’ (or adapting) the ‘mixed-mode’ current decay to optimize microstepping operation. Both logic and linear current control circuitry is included, and a 3-bit digital-to-analog converter (DAC) is used to control and ratio the output currents that are very essential to smooth, resonance-free motion.

Two distinctive attributes are incorporated in this full-bridge motor IC: a 3-bit ‘non-linear’ DAC, and the ‘mixed-decay’ PWM operation. Both are very crucial for ‘tuning’ of microstepping designs.

The full-bridge, PWM motor IC is rated to 50 V and ± 1.5 A maximums; includes integral ‘free-wheeling’ diodes for clamping inductive transients generated during switching; incorporates thermal shutdown and under-voltage protective circuitry; and internal timing prevents ‘cross-over’ currents associated with simultaneous (output) conduction.

Such benchmark functions are now very standard; however, the capability to provide ‘mixed-mode’ current decay during operation and its impact on tuning the recirculating current to best emulate a sine wave are not commonplace circuit functions.

Typically, with any ‘mixed-mode’ operation, the two quadrant, slow-decay recirculation mode is exploited during the ascending ‘half-cycle’ of the phase current. Four quadrant, fast-decay is used on the descending ‘half-cycle’ of the step motor winding current. The ratio (e.g., percentage) of fast-decay to slow-decay during this descending portion of the sine wave can be controlled to tune both drive and motor to the actual system needs.

A voltage applied to the Percent Fast-Decay (PFD) input controls and ratios the time spent in fast-decay, regenerative operation during each of the discrete PWM cycles. The outcome is much lower motor current ripple, smoother and quieter rotor movement, and reduced motor heating; but without sacrificing motor current regulation.

Per figure 1, the emulation of a sine wave using only eight (8) current ratios and a ‘mixed-mode’ drive is portrayed. In the PFD mode, switching is regulated by the internal circuitry, and a user is able to adjust or adapt the ratios of slow-decay and fast-decay. This allows ‘fine-tuning’ the driver and motor combination to match specific systems requirements, motor characteristics, etc.

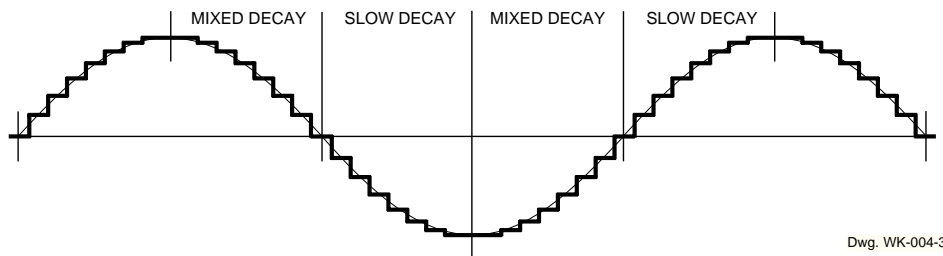

Figure 1: ‘Mixed-mode, microstepping emulation of sine wave

FULL-BRIDGE MOTOR DRIVER *with PWM CURRENT CONTROL and* **'MIXED-MODE' MICROSTEPPING**

INCREMENTAL MOTION TECHNOLOGY

Various control methods and circuit configurations offer contrasts in complexity, cost, performance, etc. The essential applications of step motors are open-loop systems that may apply various types of operating modes and drive configurations; and those that pertain to this microstepping IC include:

- Full-step Incremental motion
 - 'Wave' (single-phase) drive
 - Two-phase drive
- Fractional step incremental motion
 - Half-stepping operation
 - Quarter-stepping operation
 - Microstepping (1/8th step increments)
- Power, torque, and positional correlations
 - 'Wave' vs. two-phase drive
 - Unipolar vs. bipolar drive
 - Constant torque drive
 - Operational, usable torque
 - Torque vs. rotor displacement

The basic relationships of step motor connections and drive configurations are itemized in table 1; and A3955 current ratios listed in table 2. The bipolar-series drive is the most preferred scheme for the A3955 microstepping IC. The bipolar-parallel connection demands twice the current of bipolar-series; this raises internal dissipation and heating, and reduces the availability of integrated drivers.

Generally, the intent is to select a cost-effective unification of the step motor and drive circuitry. Frequently, this translates to a rationale to select a step motor with a lower current/higher voltage ratings combination. Such a determination offers definite benefits without any tangible

sacrifice in motion system performance; and, also, very often affords lower systems costs, less complexity, and diminished power and heating.

Full-Step Incremental Motion

'Wave' (Single-Phase) Drive

Although today seldom used in full-step designs, 'wave' drive is an integral part of microstepping. Only one winding is activated (at rated current), and a four-step sequence is depicted in figure 2. All the energized states correspond to the 'detent' (unenergized) rotor positions and are the 'natural' full-step alignments of rotor and stator.

Two-Phase Drive

Two-phase operation affords the increased torque associated with activating both coils. Compared to 'wave' (single-phase) drive the torque vector becomes 141% and the rotor alignment is 45° as shown in figure 3. However, an unenergized step motor cannot retain this 'half-step' position, and must be powered to maintain this alignment.

Table 2: Digital-to-analog truth table

D ₂	D ₁	D ₀	DAC%
1	1	1	100%
1	1	0	92.4%
1	0	1	83.1%
1	0	0	70.7%
0	1	1	55.5%
0	1	0	38.2%
0	0	1	19.5%
0	0	0	0%

Table 1: Step motor rating relationships

Mode	Power	Current	Voltage	Torque*	Time constant
1Ø, 'Wave Drive'	0.5†	1.0†	1.0	≈0.7	1
2Ø, Unipolar	1.0	1.0	1.0	1.0	1
Bipolar, Parallel	1.0	1.4	0.7	≈1.4	2
Bipolar, Series	1.0	0.7	1.4	≈1.4	2

* 'Holding' (or static) torque; step motor is energized, but not rotating.

† Per table 1, 'wave drive' operation involves switching only one winding.

FULL-BRIDGE MOTOR DRIVER

with PWM CURRENT CONTROL and 'MIXED-MODE' MICROSTEPPING

Fractional Step Increments

Half-Stepping Operation

Half-stepping necessitates driving both windings, and the simplest, most universal technique uses a 2-1-2 ON activation sequence that combines two-phase and single-phase drive. However, as illustrated in figure 4, the torque varies from the 100% value of 'wave' drive (A, B, \bar{A} , and \bar{B}) to the 141% level of two-phase drive (AB, $\bar{A}\bar{B}$, $\bar{A}\bar{B}$, and $\bar{A}\bar{B}$). Whereas the 2-1-2 drive mode induces intermediate rotor positions and smoothes rotation, it is not the best technique for half-step operation (the torque ripple is substantial).

Constant torque half-stepping follows the vectors illustrated in figure 5; and offers smoother and quieter operation than that of figure 4: output currents are ratioed (70.7%) for the two-phase increments of the cycle (AB, $\bar{A}\bar{B}$, $\bar{A}\bar{B}$, and $\bar{A}\bar{B}$). The two-phase currents that induce the half-step (45°, 135°, 225°, 315°) rotor positions, and create constant torque involve the sine and cosine vector of output A and output B (i.e., 0.707).

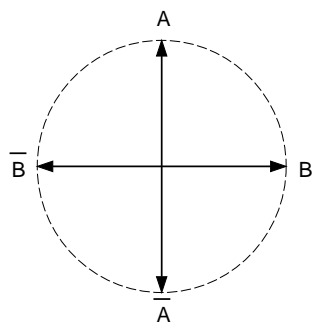

Figure 2: 'Wave' drive (1-phase)

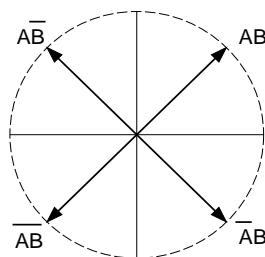

Figure 3: Two-phase, full-step

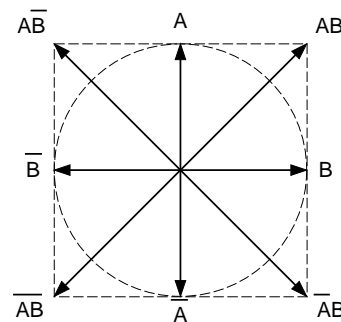

Figure 4: Half-step (2-1-2)

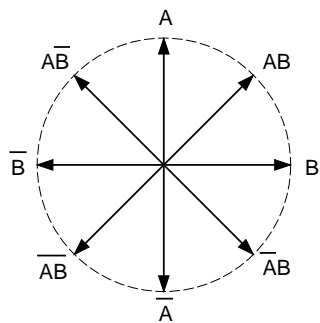

Figure 5: Half-step (constant torque)

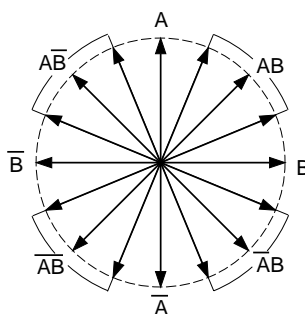

Figure 6: Quarter-step

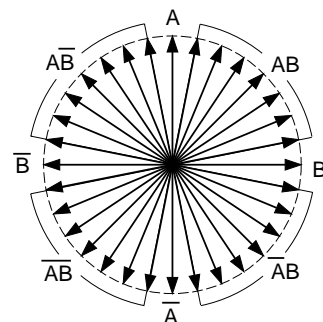

Figure 7: Microstepping

Quarter-Stepping Operation

Current ratioing and the resultant constant torque are imperative for any fractional step increments beyond the 2-1-2 half-step technique associated with figure 6. Per figure 6, quarter-stepping is incremental motion using 22.5° sub-steps. This involves combinations of 92.4% with 38.2%, and 38.2% with 92.4% to produce the rotor positions and step subdivisions represented in figure 6.

Microstepping (1/8th Step) Operation

Further subdividing one full-step into 1/8th steps is usually designated "microstepping" (figure 7). The angular increment diminishes and corresponds to 11.25°, and nine current levels are required to obtain the perfect current ratios. However, this necessitates a 4-bit DAC, and a very viable approximation is attained using the 3-bit DAC with 100% current in PHASE A ratioed with 19.5% in PHASE B. The 'ideal' phase currents are 98.1% and 19.5%, but this inconsistency is insignificant. The calculation for this 1/8th step is predicated upon decreasing coil current per: cosine of (90 ÷ 8) or 98.1%.

FULL-BRIDGE MOTOR DRIVER with PWM CURRENT CONTROL and 'MIXED-MODE' MICROSTEPPING

Because the cosine error in current (<2%) is quite negligible, and the 3-bit DAC accuracy is $\pm 3\%$ with a reference input $\geq 1.0\text{ V}$ ($\pm 4\% \leq 1.0\text{ V}$), eight current ratios can satisfy most requirements.

CONSTANT TORQUE OPERATION

Implementing quarter-stepping and microstepping is predicated upon developing the unequal, ratioed currents listed in table 2. The rotor is deflected toward the stronger pole, and the magnetic field strength is directly related to ampere turns. The equal currents (70.7%) of half stepping produce rotor positions of 45° , etc. with constant torque.

The constant torque vectors depicted in figure 8 epitomize control of the phase currents over the full-step from A ON (100%) to B ON (100%) and illustrates a 90° arc partitioned into 11.25° increments that are 1/8th step subdivisions. With a 1.8° motor (200 steps per revolution) a 1/8th-step increment equates to a 0.225° movement of the motor rotor and shaft.

MICROSTEPPING A TWO-PHASE MOTOR

Two-phase motor operation requires the winding currents differ by 90° . It should be noted that step motors can operate as synchronous motors if ac power is applied and a 90° phase difference is maintained between the winding currents.

This 90° phase current differential is illustrated in figure 9; and the diagram illustrates the phase currents in the PWM microstepping mode. Note that these 1/8th-step ratioed currents emulate the sinewave they overlay. As

will be shown later, with 'mixed-decay' operation the filtering effects of the motor windings produce output waveforms that very closely approximates a sinewave. This affords the smooth, quiet, resonance-free motion that is the primary attribute of microstepping.

The phase currents in figure 9 actually represent six full-steps, and four full-steps correspond to the sequence starting with PHASE A = 100% and PHASE B = 0%. The full series is enumerated in table 3; and the input logic sequence and motor operation correlates with the PWM microstepping waveforms illustrated in figure 9. Table 3

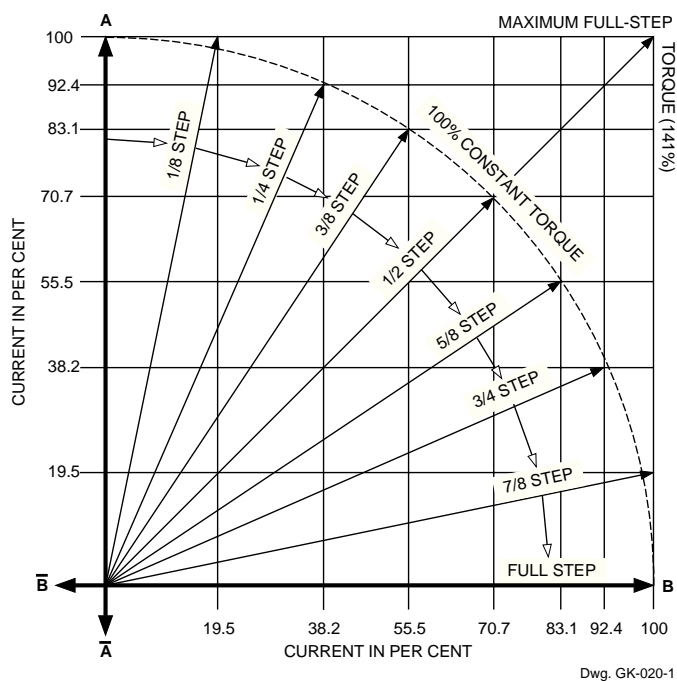

Figure 8: Constant-torque vectors

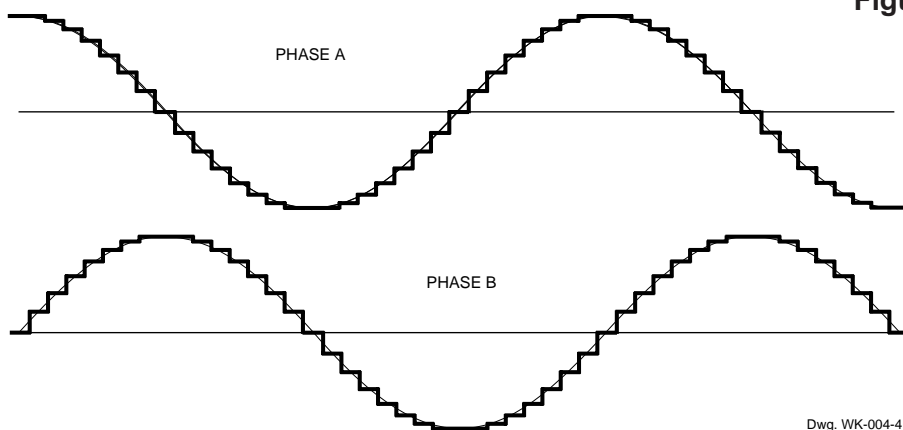

Figure 9: Phase current waveforms (microstepping mode)

FULL-BRIDGE MOTOR DRIVER
with PWM CURRENT CONTROL and
'MIXED-MODE' MICROSTEPPING

Table 3: Input logic sequence and operating modes for two-phase step motor

Driver IC #1							Driver IC #2							Step Motor		
(Phase A)							(Phase B)							Torque		
Ø	D2	D1	D0	PFD	Current	MO	Ø	D2	D1	D0	PFD	Current	MO	Value	Angle	Δ∠
1	1	1	1	1	100.0%	S	0	0	0	0	0	0.0%	D	1.000	0.00	11.03
1	1	1	1	0	100.0%	M	1	0	0	1	1	19.5%	S	1.019	11.03	11.03
1	1	1	0	0	92.4%	M	1	0	1	0	1	38.2%	S	1.000	22.46	11.43
1	1	0	1	0	83.1%	M	1	0	1	1	1	55.5%	S	0.999	33.74	11.28
1	1	0	0	0	70.7%	M	1	1	0	0	1	70.7%	S	1.000	45.00	11.26
1	0	1	1	0	55.5%	M	1	1	0	1	1	83.1%	S	0.999	56.26	11.26
1	0	1	0	0	38.2%	M	1	1	1	0	1	92.4%	S	1.000	67.54	11.28
1	0	0	1	0	19.5%	M	1	1	1	1	1	100.0%	S	1.019	78.97	11.43
0	0	0	0	0	0.0%	D	1	1	1	1	1	100.0%	S	1.000	90.00	11.03
0	0	0	1	1	-19.5%	S	1	1	1	1	0	100.0%	M	1.019	101.03	11.03
0	0	1	0	1	-38.2%	S	1	1	1	0	0	92.4%	M	1.000	112.46	11.43
0	0	1	1	1	-55.5%	S	1	1	0	1	0	83.1%	M	0.999	123.74	11.28
0	1	0	0	1	-70.7%	S	1	1	0	0	0	70.7%	M	1.000	135.00	11.26
0	1	0	1	1	-83.1%	S	1	0	1	1	0	55.5%	M	0.999	146.26	11.26
0	1	1	0	1	-92.4%	S	1	0	1	0	0	38.2%	M	1.000	157.54	11.28
0	1	1	1	1	-100.0%	S	1	0	0	1	0	19.5%	M	1.019	168.97	11.43
0	1	1	1	1	-100.0%	S	0	0	0	0	0	0.0%	D	1.000	180.00	11.03
0	1	1	1	0	-100.0%	M	0	0	0	1	1	-19.5%	S	1.019	191.03	11.03
0	1	1	0	0	-92.4%	M	0	0	1	0	1	-38.2%	S	1.000	202.46	11.43
0	1	0	1	0	-83.1%	M	0	0	1	1	1	-55.5%	S	0.999	213.74	11.28
0	1	0	0	0	-70.7%	M	0	1	0	0	1	-70.7%	S	1.000	225.00	11.26
0	0	1	1	0	-55.5%	M	0	1	0	1	1	-83.1%	S	0.999	236.26	11.26
0	0	1	0	0	-38.2%	M	0	1	1	0	1	-92.4%	S	1.000	247.54	11.28
0	0	0	1	0	-19.5%	M	0	1	1	1	1	-100.0%	S	1.019	258.97	11.43
1	0	0	0	0	0.0%	D	0	1	1	1	1	-100.0%	S	1.000	270.0	11.03
1	0	0	1	1	19.5%	S	0	1	1	1	0	-100.0%	M	1.019	281.03	11.03
1	0	1	0	1	38.2%	S	0	1	1	0	0	-92.4%	M	1.000	292.46	11.43
1	0	1	1	1	55.5%	S	0	1	0	1	0	-83.1%	M	0.999	303.74	11.28
1	1	0	0	1	70.7%	S	0	1	0	0	0	-70.7%	M	1.000	315.00	11.26
1	1	0	1	1	83.1%	S	0	0	1	1	0	-55.5%	M	0.999	326.26	11.26
1	1	1	0	1	92.4%	S	0	0	1	0	0	-38.2%	M	1.000	337.54	11.28
1	1	1	1	1	100.0%	S	0	0	0	1	0	-19.5%	M	1.019	348.97	11.43
1	1	1	1	1	100.0%	S	1	0	0	0	0	0.0%	D	1.000	360.00	11.03

Input codes: Ø = PHASE input (direction); PFD = percent fast-decay; MO = operating mode

Operating modes: D = disabled (OUTPUT OFF); S = slow-decay; M = 'mixed-mode' decay

Motor codes: Value = torque vector magnitude; Angle = rotor position; Δ∠ = delta angle

NOTE: The logic sequencing and operating modes pertain to four full steps of figure 9.

FULL-BRIDGE MOTOR DRIVER with PWM CURRENT CONTROL and 'MIXED-MODE' MICROSTEPPING

lists the complete 32 fractional (1/8th) steps required to rotate the motor four (4) full-steps (i.e., 7.2° with a 1.8° , (200 steps-per-revolution motor), and corresponds with the vector diagram denoted in figure 7. Note that both torque magnitude and incremental angles ($\Delta\angle$) are very consistent; this effectively illustrates the constant torque vectors and the sine/cosine phase current relationships.

Whereas microstepping can provide an increased positional resolution, its primary benefit is quiet, smooth and resonance-free motion (especially at the lower step rates). The reduction in overshoot and ringing (the system oscillation that follows an abrupt change in either velocity or position) is depicted in figure 10. Also, the linearity of the time and position relationship is very evident, and this characteristic supports decreasing the elapsed time for the system movements.

OPEN-LOOP MICROSTEPPING

Most step motors operate in an 'open-loop' mode (no positional or velocity feedback signals); this (essentially) affords the benefits of lower system complexity and costs. However, the capability to attain improved positional accuracy and resolution is another prospect for microstepping. Typically, the most critical element to realizing intermediate positions is the motor itself, and motors with low 'detent' torque (also known as 'residual' or 'idle' torque) consistently surpass standard versions that have higher detent torque specifications.

Designers intending to increase system positional resolution should evaluate the drive circuitry and motor response if microstepping is used to extend incremental motion by subdividing the steps. The rotor may (or may not) follow the current ratios; thus, the resulting angular displacement can often be quite non-linear. The torque vs. displacement characteristics depicted in figure 11A are clearly not suitable for accurately subdividing a step; but the torque/displacement properties of Motor #2 in figure 11B are very linear and uniform and well suited for increasing positional resolution.

Matching/mating the drive circuitry with the step motor can surmount such non-linearity; however, using step motors designed and manufactured for microstepping is often the most reliable and best solution to accurate, uniform fractional steps. Practically, open-loop microstepping is exploited for smooth, quiet motion (even

at very low step frequencies) to circumvent resonance and audible vibration, and to reduce settling times (decreased ringing and overshoot compared to full-step). In most instances, especially designs exploiting very small 'can-stack' motors, subdividing a full-step cannot (readily) assure that a precise, repeatable incremental rotor displacement is the result.

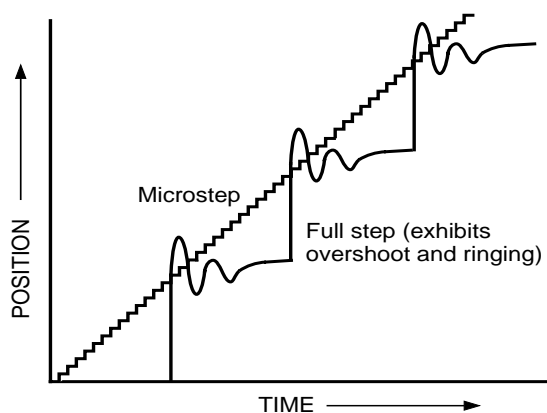

Figure 10: Step motor settling time
(Courtesy of Compumotor Division of Parker Hannifin Corp.)

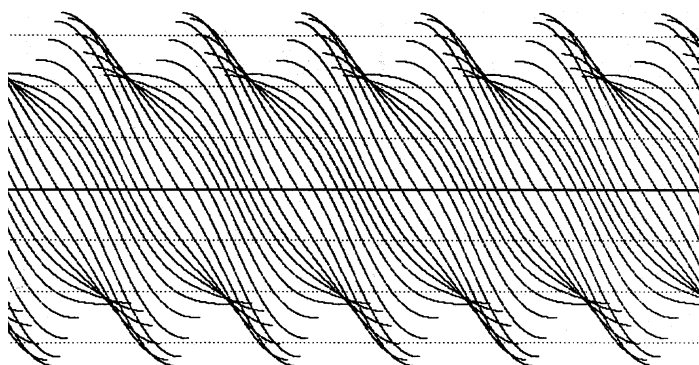

Figure 11A: Torque vs. displacement (motor #1)

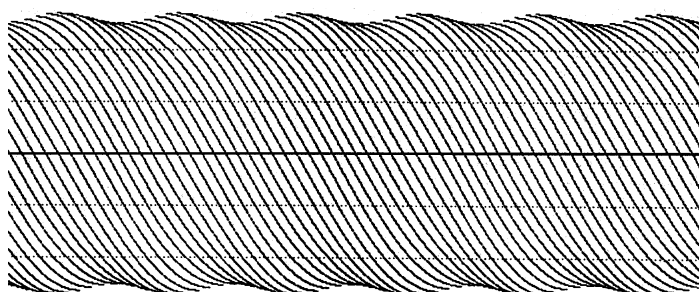

Figure 11B: Rotor vs. displacement (motor #2)
(Courtesy of Litchfield Engineering; Kingman, AZ)

FULL-BRIDGE MOTOR DRIVER

with PWM CURRENT CONTROL and 'MIXED-MODE' MICROSTEPPING

STEP MOTOR CONTROL/DRIVE SYSTEM

Designed for small, low-cost step-motor drives, two A3955s, plus the external, passive discrettes, are required to power both coils of a two-phase step motor. The functional block diagram shown in figure 12 represents the circuitry designed for directly controlling and driving each of the step motor windings (two per motor are required).

Typically, only three external passive components (per coil) are needed; a current-sensing resistor, R_S , plus the RC network (R_T , C_T) required to set the fixed OFF-time interval for PWM operation.

ELEMENTS of MOTOR CURRENT CONTROL

Directional Control of Motor Current

The PHASE input controls the direction of current flow to the motor. A logic-high level applied to the PHASE input

switches both $OUTPUT_A$ high and $OUTPUT_B$ low; this corresponds to a positive (left-to-right) current that is associated with the upper portion of the sinewave shown in figure 1, and the drive current path shown in figure 13.

An internally developed 'dead-time' ($\approx 1.5 \mu s$) interval when switching the PHASE input (changing current direction) precludes damaging/destructive 'cross-over' currents associated with overlapping (i.e., simultaneous) conduction of upper and lower outputs. Exploiting this 'deadtime' interval avoids dynamic (switching) mismatches that can result in a momentary 'shorting' of the supply to ground through an overlapping ON state of the upper and lower outputs. Obviously, 'cross-over' currents can damage or destroy the IC and must be averted.

These 'shoot-through' currents are related to the upper (sourcing) outputs and their (much) slower turn-OFF characteristics (vs. the sinking outputs).

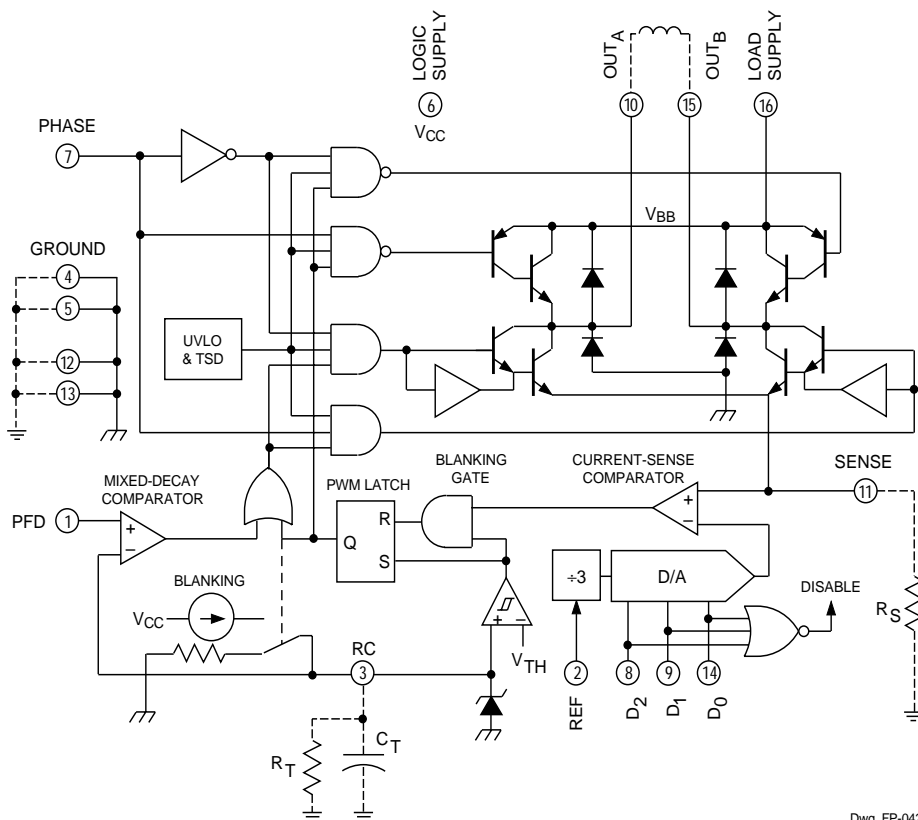

Figure 12: Functional block diagram of 'mixed-mode, driver IC (A3955)

Dwg. FP-042

FULL-BRIDGE MOTOR DRIVER with PWM CURRENT CONTROL and 'MIXED-MODE' MICROSTEPPING

Power Output Operation and Truth Table

In addition to directional control, the operation of the motor IC is governed by: three logic inputs to the digital-to-analog converter (DAC); a stable, fixed reference voltage (although this could also entail a 0.5 V to 2.5 V range to adjust the PWM current); plus the circuitry that controls the PFD (percent fast-decay) input. The device operates per the conditions listed in table 4 (Output Truth Table/Recirculation Modes for the microstepping IC).

Per table 4, the outputs are completely disabled when the digital signals (D_0, D_1, D_2) are LOW. As mentioned, the

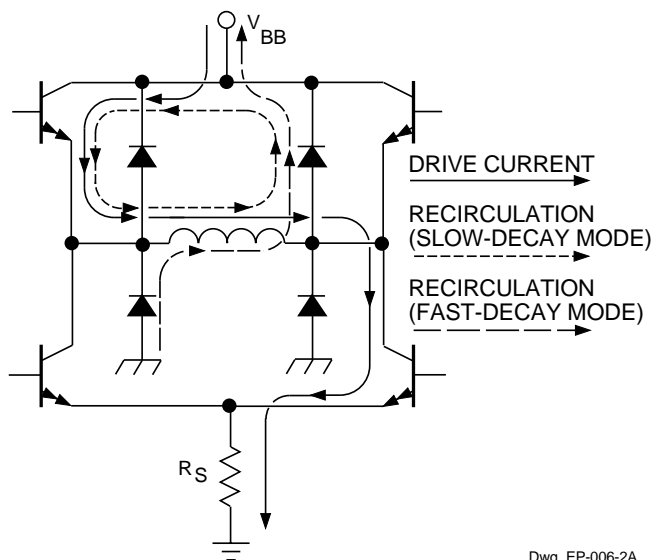

Figure 13: Load and recirculation currents

current direction is determined by the PHASE input, and the recirculating current decay mode is governed by the voltage applied to the PFD input. Properly 'tuning' the ratio of fast and slow decay allows minimizing current ripple, and with suitable control the PFD voltage can be dynamically varied for optimal performance over a broad range of step frequencies.

The specified winding current (100%) is derived from a formula consisting of a suitable reference voltage and current-sensing resistor. Per tables 2 and 4, the 100% value is delivered when the DAC inputs ($D_2, D_1,$ and D_0) are all high (1); and the calculations are predicated upon:

$$I_{TRIP} = V_{REF}/(3 \cdot R_S)$$

$$R_S = V_{REF}/(3 \cdot I_{TRIP})$$

The phase currents are determined by the 3-bit DAC inputs and the formula above; per table 2, the PWM current supplied to each motor winding involves correctly ratioing phase currents to attain constant torque. Hence, Step Reference Current Ratio (SRCR) is another factor in calculating the actual current applied to develop constant torque; and the phase current formula becomes:

$$I_{TRIP} = V_{REF} \cdot SRCR / (3 \cdot R_S)$$

The phase current ratios (SRCR) associated with the 3-bit DAC are enumerated in table 2, and it should be noted that the logic sequence follows the binary format used in up-down counters, etc. Thus, 'hardware' motion control is very viable.

Table 4: Output truth table and recirculation modes

D_2	D_1	D_0	Phase	PFD	Out _A	Out _B	Description
0	0	0	X	X	OFF	OFF	Outputs disabled
			1	$>0.6 \cdot V_{CC}$	H	L	Slow current decay
	All		1	$(0.22 \text{ to } 0.6) V_{CC}$	H	L	Mixed current decay
	other		1	$<0.22 \cdot V_{CC}$	H	L	Fast current decay
			0	$>0.6 \cdot V_{CC}$	L	H	Slow current decay
	input		0	$(0.22 \text{ to } 0.6) V_{CC}$	L	H	Mixed current decay
	states		0	$<0.22 \cdot V_{CC}$	L	H	Fast current decay

FULL-BRIDGE MOTOR DRIVER with PWM CURRENT CONTROL and 'MIXED-MODE' MICROSTEPPING

'MIXED-MODE' MICROSTEPPING

Following on the essentials of incremental motion technology is a discussion of the operation and of the benefits of 'mixed-mode' microstepping. At the outset, it was pointed out that the circuitry is utilized to emulate a sinewave drive to the motor windings. Figure 9 illustrated the coil currents, and table 3 enumerated the input control signals, etc. required to complete a four-step cycle, which then repeats to microstep the motor.

Frequently, with step motor applications there are instances when Slow Decay recirculation fails to properly control (e.g., regulate) the phase current. 'Mixed-Mode' Decay fragments the PWM fixed-OFF time into intervals of both Fast- and Slow Decay, and solves those situations where only the slowly decaying (i.e., two-quadrant) recirculation proves incapable of following the descending half of a sinewave current. This is especially evident in microstepping designs and transpires as current decay is impeded by the back EMF and inductive properties of the motor and decays too slowly.

Utilizing fast-decay during a portion of the fixed OFF time offers improved current regulation, but 100% fast-decay can induce excessive ripple in the load current.

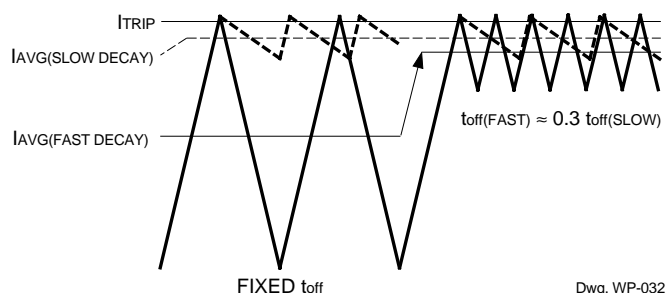

Figure 14: Current waveforms (three modes)

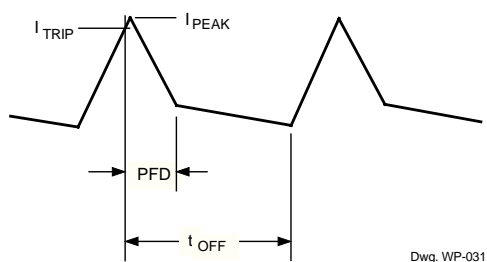

Figure 15: 'Mixed decay, current waveform

'Mixed-Decay' offers a mode that allows 'tuning' the proper ratio of fast- and slow-decay to optimize motor current regulation without creating undue, undesirable heating. Per figure 14, the fast-decay current excursions are much greater than either the slow-decay (dotted) or 'mixed-mode' [$t_{off(FAST)} \approx 0.3 t_{off(SLOW)}$].

Although the current ripple in 'mixed-mode' has heightened, it is much lower than the fast-decay mode. The 'mixed-mode' operation is controlled by comparing the (fixed-OFF time) RC voltage to the PFD voltage determined by the user. The output of the mixed-decay comparator determines the portion of each PWM cycle that the driver IC spends in fast- or slow-decay. Per table 4, for mixed-decay operation the PFD voltage must be within the range of $0.22 \cdot V_{CC}$ and $0.6 \cdot V_{CC}$.

A resistor divider can establish this PFD voltage; thus, as a PWM decay period commences, the IC starts in the fast-decay mode. When the voltage on the RC network declines to a value below the PFD input, the device switches into slow decay. The percentage of the PWM OFF-time spent in fast decay is derived via the divider R_1 and R_2 :

$$\% \text{ Fast-Decay} = 100 \cdot \ln 0.6 \cdot (R_1/R_2 + 1)$$

An illustration of 'mixed-decay' PWM appears in figure 15; and, commencing at the peak current (I_{TRIP}), fast decay (PFD) is initiated. The fixed OFF time is divided into approximately one third fast-decay and the remaining portion operating in the slow-decay mode. An RC network fixes this OFF-time interval, and a parallel resistor (R_T) and capacitor (C_T) establish the t_{OFF} as follows:

$$t_{OFF} \approx R_T \cdot C_T$$

Per figure 15, when the RC voltage has dropped to its lower limit ($\approx 0.22 \cdot V_{CC}$), the PWM latch is again set and the driver(s) switched ON. This restores conduction to the motor winding and the current ramps to the design trip value, and PWM operation continues until the control logic changes the current value or direction.

The RC network capacitor (C_T) also establishes the comparator blanking time. Functionally, this blanks the comparator output during any switching involving the internal control circuitry (change of direction or enabling DAC inputs); and precludes erroneous current detection during switching.

FULL-BRIDGE MOTOR DRIVER *with PWM CURRENT CONTROL and* **'MIXED-MODE' MICROSTEPPING**

The benefits of 'mixed-mode' decay can readily be illustrated via a number of oscilloscope plots. While the focus is upon microstepping, the other modes of operation are included for comparative purposes. Because the primary thrust is emulating a sinewave, only a few token illustrations of half- and quarter-stepping are included. All examples illustrate operation at ± 1.0 A, and each figure is labeled with its step rate and recirculation data.

For comparison purposes, 50 steps per second, half-step operation is depicted in figures 16, 17, and 18. Per notations, figure 16 illustrates 100% slow-decay; figure 17 portrays operation with 100% fast-decay, and figure 18 depicts 50% ratios of fast- and slow-decay. At this stepping rate, the fast-decay mode offers the most desirable result as portrayed by the 'clean' half-step waveform.

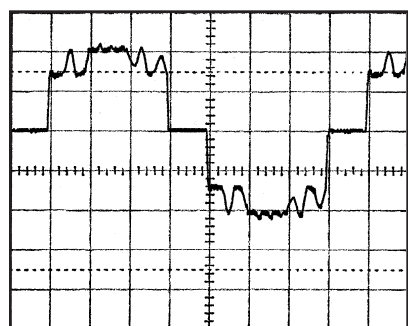

Figure 16: 1/2 Step, 50 steps per second, 100% slow

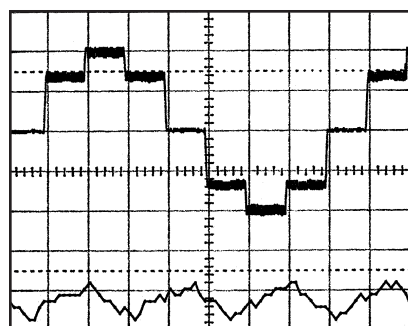

Figure 17: 1/2 Step, 50 steps per second, 100% fast

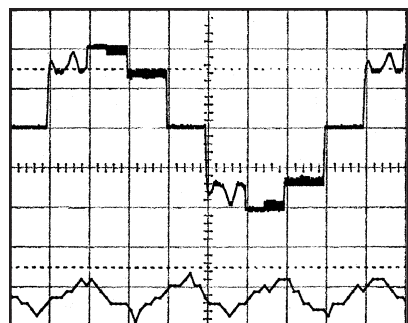

Figure 18: 1/2 Step, 50 steps per second, 50%/50% mixed

Shifting to quarter-stepping displays (again) that 100% fast-decay offers the preferred waveform (figure 19), but 100% slow-decay (figure 20) is a poor 'third' to the 50%/50% of figure 21, and very similar to the 50%/15%/35% 'mixed-decay' represented in figure 22.

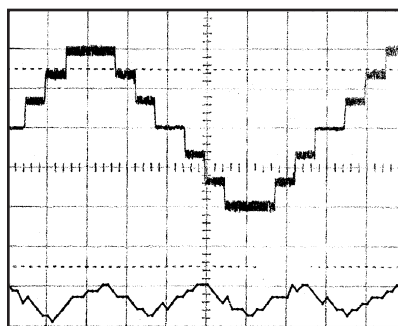

Figure 19: 1/4 Step, 50 steps per second, 100% fast

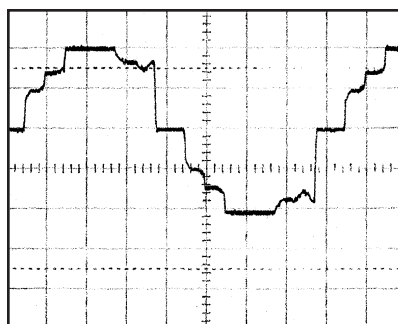

Figure 20: 1/4 Step, 0 steps per second, 100% slow

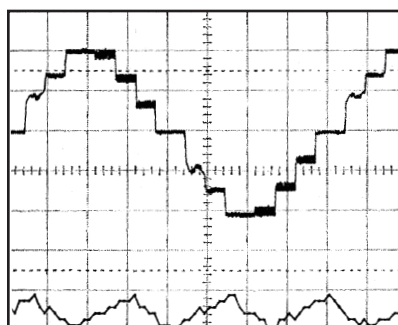

Figure 21: 1/4 Step, 50 steps per second, 50%/50% mixed

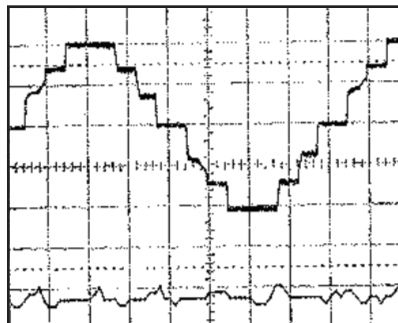

Figure 22: 1/4 Step, 50 steps per second, 50%/15%/35% mixed

FULL-BRIDGE MOTOR DRIVER with **PWM CURRENT CONTROL** and **'MIXED-MODE' MICROSTEPPING**

Continuing with 50 Hz plots, figure 23 displays a 1/8th-step waveform that exhibits considerable 'distortion' of the desired sinewave. Aberrations on both ascending and descending portions of the waveform are very obvious, and this operation is neither desirable nor very acceptable. Figure 24 follows the sine curve much better, but registers much larger current ripple at each subdivision of stepping. Figure 25 indicates some improvement, but figure 26 represents lower current ripple at this step rate with microstepping (1/8th steps).

Slow decay performs very poorly as the stepping rate increases, and the 100% slow recirculation shown in figure 27 does not emulate a sinusoidal waveform. Hereon, only the microstepping mode (1/8th steps) is illustrated and contrasted. Because microstepping is most advantageous at the lower to mid-range stepping frequen-

cies, only the most pertinent plots are included. Figures 28 and 30 portray the optimal waveforms at the rates noted, and figure 29 makes it apparent that the fast-to-slow-decay (PFD) is linked to the stepping rate. 50%/15%/35% serves >100 Hz, but not 200 Hz.

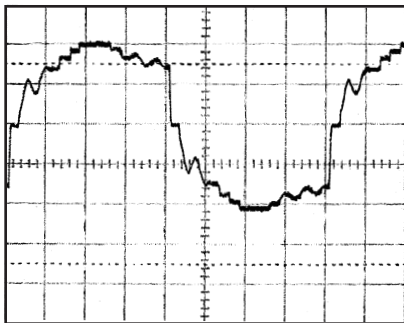

Figure 23: 1/8th Step, 50 steps/second, 100% slow

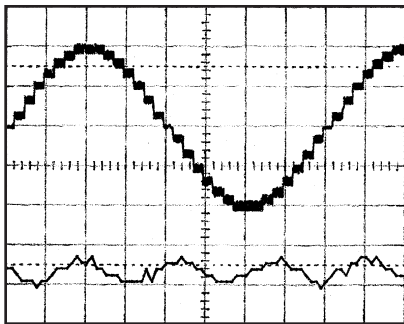

Figure 24: 1/8th Step, 50 steps/second, 100% fast

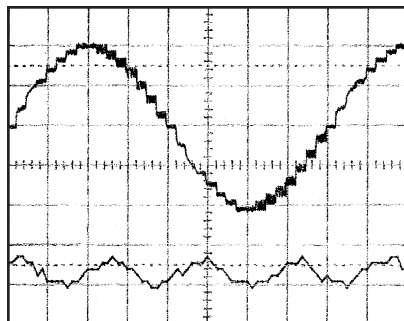

Figure 25: 1/8th Step, 50 steps/second, 50%/50% mixed

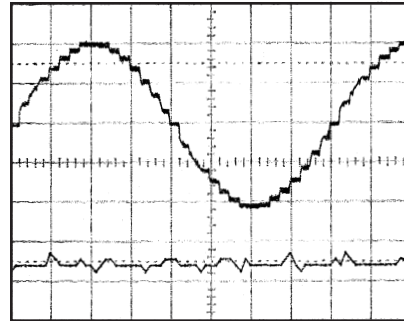

Figure 26: 1/8th Step, 50 steps/second, 50%/15%/35% mixed

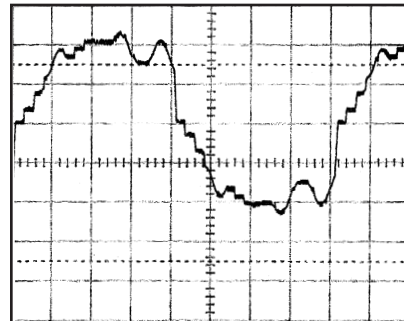

Figure 27: 1/8th Step, 100 steps/second, 100% slow

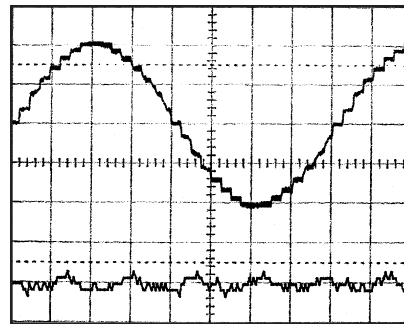

Figure 28: 1/8th Step, 100 steps/second, 50%/15%/35% mixed

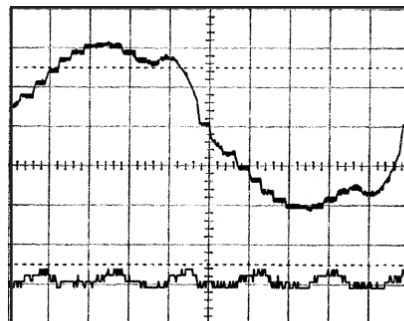

Figure 29: 1/8th Step, 200 steps/second, 50%/15%/35% mixed

FULL-BRIDGE MOTOR DRIVER *with PWM CURRENT CONTROL and* **'MIXED-MODE' MICROSTEPPING**

Once beyond the resonance range (usually from ≈ 50 -150 Hz), the motor can be operated in the full-step mode for slewing, and then be switched to microstepping for deceleration. However, for a broad stepping range with fixed PFD, the 50% plots shown in figures 25, 30, 31, 32, and 33 depict the preferred waveforms (many other plots omitted due to space limitations).

For optimal performance, 'dynamically' switching the PFD ratio in correlation to the stepping rate, and the specific motor characteristics, is feasible. Obviously, the control logic (perhaps a dedicated microcontroller) and software are more complex than a 'fixed' 50%/50% PFD ratio solution such as the easy voltage divider, broad-range solution represented in figures 25, 30, 31, 32, and 33.

SUMMARY and CONCLUSION

The A3955 is an innovative, full-bridge, PWM step motor driver IC created for modest power, cost-sensitive microstepping applications. The IC is capable of constant current (PWM) drive of one phase (one winding) of a two-phase motor, and rated to maximums of 50 V and ± 1.5 A.

Ratioed currents provide constant-torque operation and are controlled via three logic inputs and a 3-bit DAC with $\pm 3\%$ accuracy. PWM current control involves one current-sensing resistor, an RC network for fixed OFF time, and a reference voltage.

The fundamentals of incremental motion control from 'wave-drive' through microstepping (1/8th steps) were summarized for their applicability to this 'mixed-mode' step motor drive IC. The IC is best suited for the bipolar-series configuration; and, as illustrated in various figures, the 'mixed-mode', 1/8th-step operation delivers a waveform that quite effectively emulates a sine wave.

Either a fixed PFD voltage, which determines the ratio of slow- and fast-decay, or operation with dynamic 'tuning' (i.e., adjusting the PFD potential based upon the step rate) is feasible. Operation with a fixed PFD input voltage can (as shown) deliver smooth microstepping over a rather broad range of stepping speeds. However, each system should be evaluated for its specific characteristics as the step motor is the foremost factor affecting overall performance. Subdividing each full step to extend the positional resolution is also directly and distinctly related to the motor characteristics.

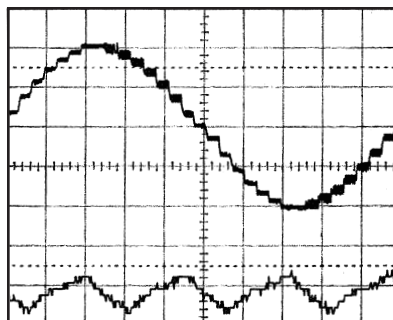

Figure 30: 1/8th Step, 200 steps/second, 50%/50% mixed

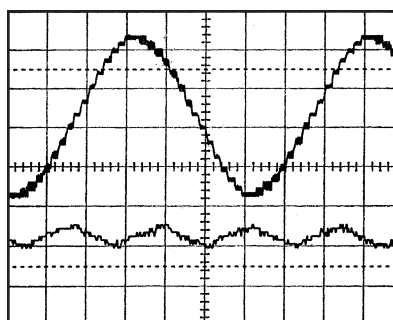

Figure 31: 1/8th Step, 333 steps/second, 50%/50% mixed

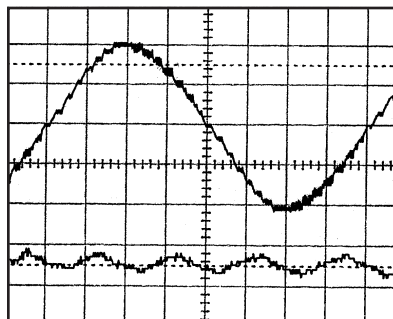

Figure 32: 1/8th Step, 500 steps/second, 50%/50% mixed

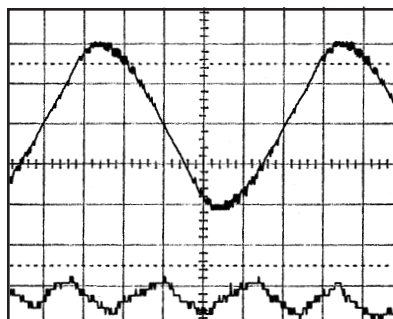

Figure 33: 1/8th Step, 666 steps/second, 50%/50% mixed

The products described here are the A3955SB and A3955SLB full-bridge PWM microstepping motor drivers. This paper was originally presented at PCIM'97 in Hong Kong, October 14-17, 1997. Reprinted by permission.